

ZETTLER DISPLAYS

SPECIFICATIONS FOR LIQUID CRYSTAL DISPLAY

CUSTOMER APPROVAL			
※ PART NO. : <u>AQM2416D-FLW-FBE-T(ZETTLER DISPLAYS) VER1.0</u>			
APPROVAL		COMPANY CHOP	
CUSTOMER COMMENTS			

ZETTLER DISPLAYS ENGINEERING APPROVAL		
DESIGNED BY	CHECKED BY	APPROVED BY
Jacky Li		GU ZH

REVISION RECORD

REVISION	REVISION DATE	PAGE	CONTENTS
VER1.0	2017-12-27		FIRST ISSUE

※ **CONTENTS**

- 1.0 GENERAL SPECS
- 2.0 ABSOLUTE MAXIMUM RATINGS
- 3.0 ELECTRICAL CHARACTERISTICS
- 4.0 OPTICAL CHARACTERISTICS
- 5.0 BLOCK DIAGRAM
- 6.0 PIN ASSIGNMENT
- 7.0 POWER SUPPLY
- 8.0 TIMING CHARACTERISTICS
- 9.0 MECHANICAL DIAGRAM
- 10.0 RELIABILITY TEST
- 11.0 DISPLAY CONTROL INSTRUCTION
- 12.0 APPEARANCE CRITERIA
- 13.0 PRECAUTION FOR USING LCM
- 14.0 TEST REPORT
- 15.0 PICTURE

1.0 GENERAL SPECS

1. Display Format	240*160 Dots
2. Power Supply	3.3V
3. Overall Module Size	98.7mm(W) x 64.2mm(H) x9.8mm(D)
1. Viewing Area(W*H)	78.5mm(W) x 47.5mm(H)
2. Dot Size (W*H)	0.270mm(W) x 0.255mm(H)
3. Dot Pitch (W*H)	0.290mm(W) x 0.275mm(H)
4. Viewing Direction	6:00 O'Clock
5. Driving Method	1/160Duty,1/12Bias
6. Controller IC	ST7586 or compatible
7. Display Mode	FSTN/Positive/Transflective
8. Backlight Options	White LED/Side
9. Operating temperature	-30°C ~ 80°C
10. Storage temperature	-30°C ~ 85°C
11. RoHS	RoHS compliant

2.0 ABSOLUTE MAXIMUM RATINGS

Item	Symbol	Min	Typ	Max	Unit
Operating temperature	Top	-30	-	80	°C
Storage temperature	Tst	-30	-	85	°C
Input voltage	Vin	Vss-0.3	--	Vdd+0.3	V
Supply voltage for logic	Vdd- Vss	-0.3	-	4.0	V
Supply voltage for LCD driving	V0-Vss	4.0	-	18.0	V

3.0 ELECTRICAL CHARACTERISTICS

3.1 Electrical Characteristics Of LCM

Item	Symbol	Condition	Min	Typ	Max	Unit
Power Supply Voltage	Vdd	25°C	--	3.3	--	V
Power Supply Current	Idd	Vdd=3.3V	--	1.5	5.0	mA
Input voltage (high)	Vih	Pins:(RS,/WR,/RD,/RST ,/CS,D0-D7),	0.8Vdd	--	Vdd	V
Input voltage (low)	Vil		Vss	--	0.2Vdd	V
Recommended Driving Voltage	LC V0-Vss	-30°C	--	--	--	V
		25°C	--	14.8	--	
		80°C	--	--	--	

3.2 The Characteristics Of LED Backlight

3.2.1 Electrical-Optical Characteristics Of LED Backlight (Ta=25°C)

Item	Symbol	Condition	Min	Typ	Max	Unit
Forward Voltage ⁽¹⁾	Vf	If=75mA	2.9	3.1	3.3	V
Reverse Voltage	Vr	-	--	--	5	V
Luminance ^(2,3)	Lv	If=75mA	150	200	--	cd/m ²
Uniformity	Δ	(Lvmin/Lvmax)%	70%	--	--	-
Peak wave length	λp	-	--	--	--	nm
Chroma coordinate	x	If=75mA	0.26	--	0.30	um
	y	If=75mA	0.27	--	0.31	um
Lifetime ⁽⁴⁾	-	If=75mA	-	20000	-	Hours

NOTE:

(1) Forward voltage means voltage applied directly to the LED, please refer to the backlight diagram.

(2)Luminance means the backlight brightness without LCD.

(3)The luminance is the average value of 5 points, The measurement instrument is BM-7 luminance colorimeter. The diameter of aperture is Φ5mm,

(4) Backlight lifetime means luminance value larger than half of the original after 20000 hours' continuous working.

3.2.2 Backlight Control Circuit FOR LCM (1x5=5 pcs LED)

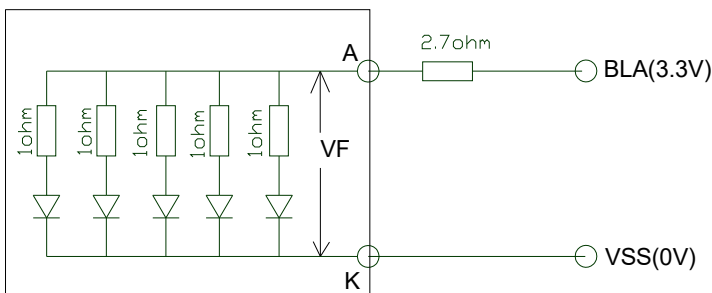

3.2.3 LED Characteristics Curves (for single led)

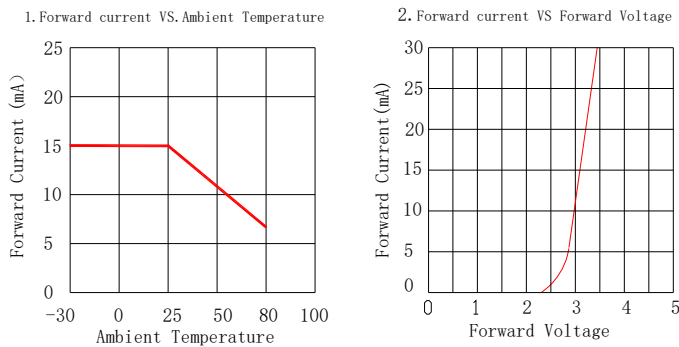

4.0 OPTICAL CHARACTERISTICS (Ta=25°C)

Item	Symbol	Condition	Min	Typ	Max	Unit
Viewing angle (Left - right)	θ_2	$Cr \geq 2.0$	-30	-	30	deg
Viewing angle (Up-down)	θ_1	$Cr \geq 2.0$	-30	-	20	deg
Contrast Ratio	Cr	$\theta_1=0^\circ, \theta_2=0^\circ$	-	4	-	
Response time (rise)	Tr	$\theta_1=0^\circ, \theta_2=0^\circ$	-	240	-	ms
Response time (fall)	Tf	$\theta_1=0^\circ, \theta_2=0^\circ$	-	256	-	ms

(1). Definition of Optical Response Time

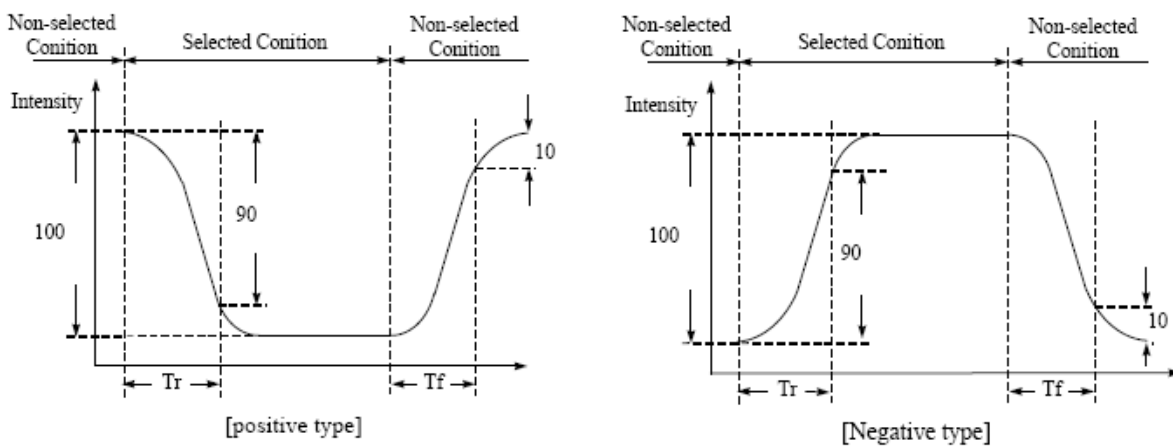

(2). Definition of Contrast Ratio

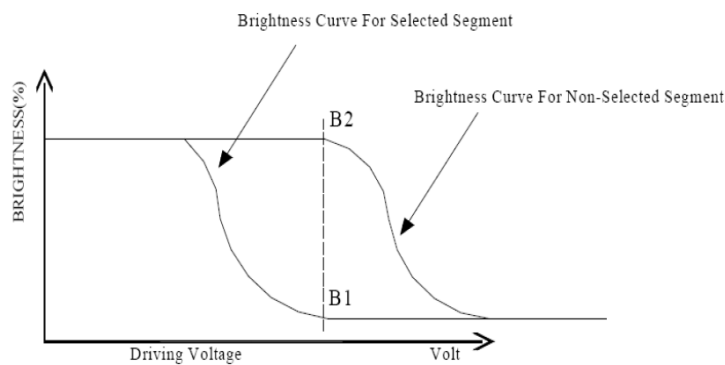

$$Cr = \frac{\text{Brightness of Non-selected Segment}(B2)}{\text{Brightness of selected Segment}(B1)}$$

(3). Definition of Viewing Angle θ_2 and θ_1

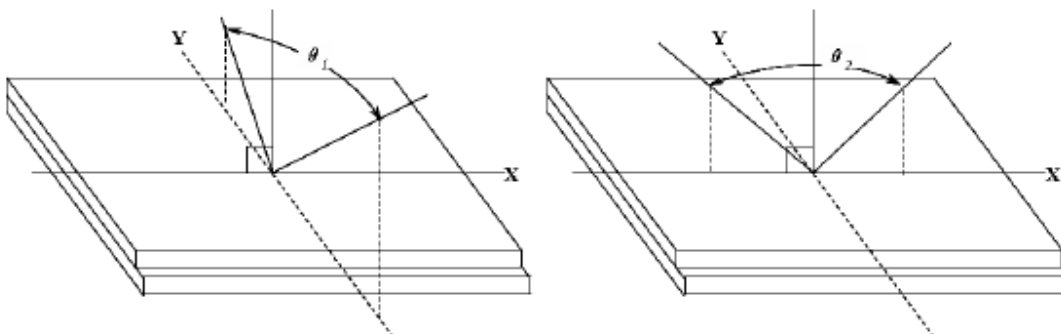

5.0 BLOCK DIAGRAM

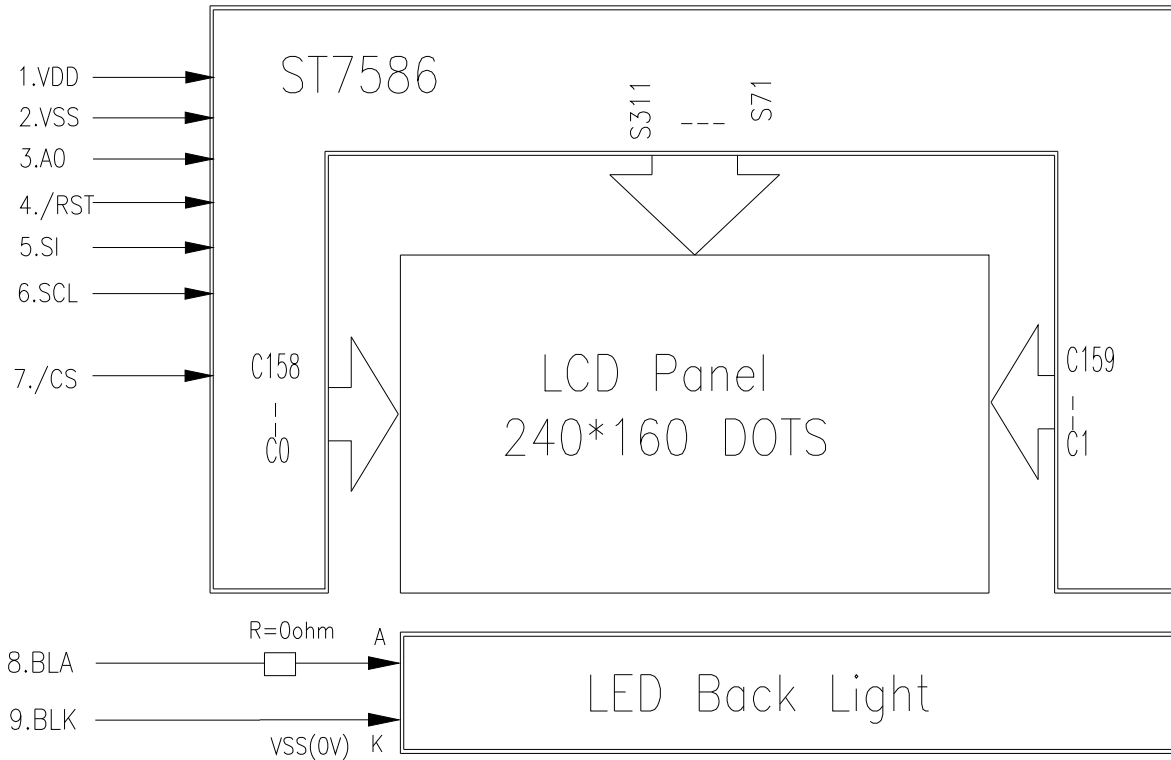

6.0 PIN ASSIGNMENT

Pin No.	Symbol	Function
1	VDD	Power Supply(3.3V)
2	VSS	GND(0V)
3	A0	Data/command select
4	/RST	Reset signal
5	SI	Serial data
6	SCL	Serial clock
7	/CS	Chip select
8	A	Anode electrode of LED backlight
9	K	Cathode electrode of LED backlight

7.0 POWER SUPPLY

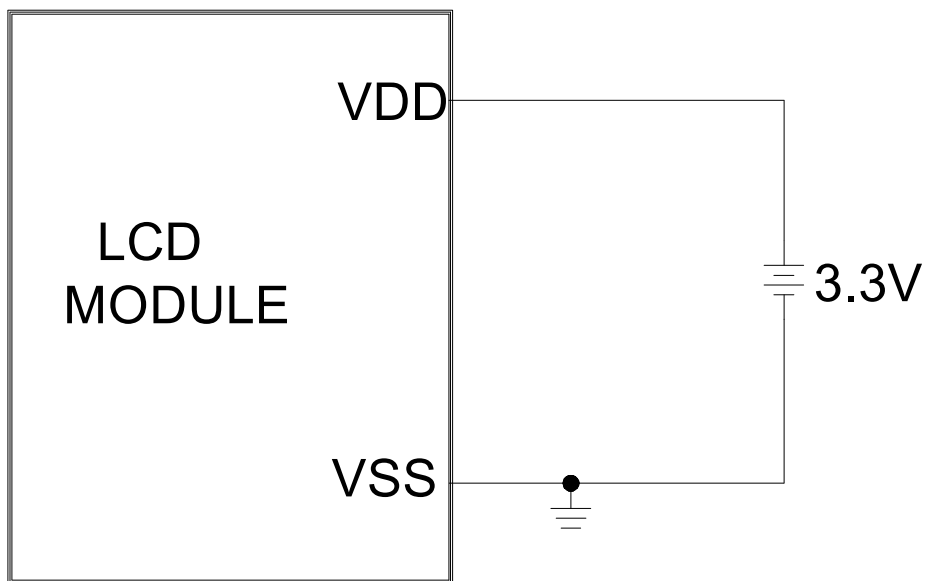

8.0 TIMING CHARACTERISTICS

System Bus Timing for 4-Line SPI MCU Interface

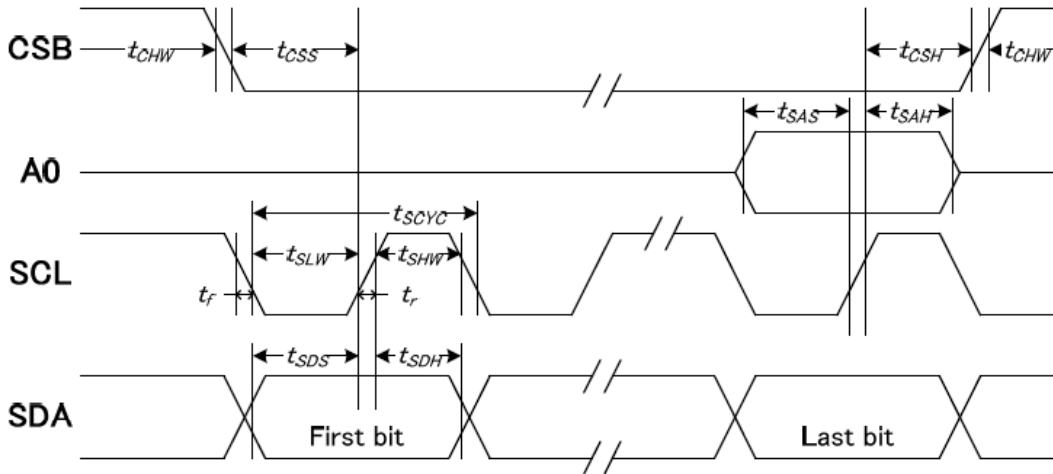

VDD1 = 1.8~3.3V, Ta = 25°C

Item	Signal	Symbol	Condition	Min.	Max.	Unit
Serial clock period		tSCYC		100	—	ns
SCLK "H" pulse width	SCLK	tSHW		45	—	
SCLK "L" pulse width	SCLK	tSLW		45	—	
Address setup time	A0	tSAS		20	—	
Address hold time	A0	tSAH		20	—	
Data setup time	SDA	tSDS		20	—	
Data hold time	SDA	tSDH		20	—	
CSB-SCLK time	CSB	tCSS		20	—	
CSB-SCLK time	CSB	tCSH		20	—	
CS "H" pulse width	CSB	tCHW		0	—	

Note:

1. The input signal rise and fall time (tr, tf) are specified at 15 ns or less.
2. All timing is specified using 20% and 80% of VDD1 as the standard.

VDD1 = 1.8~3.3V, Ta = 25°C

Item	Signal	Symbol	Condition	Rating		Unit
				Min.	Max.	
Serial Clock Period		tSCYC		100	—	ns
SCL "H" pulse width	SCLK	tSHW		45	—	
SCL "L" pulse width	SCLK	tSLW		45	—	
Data setup time	SDA	tSDS		20	—	
Data hold time	SDA	tSDH		20	—	
CS-SCL time	CSB	tCSS		30	—	
CS "H" pulse width	CSB	tCHW		0	—	

Note:

1. The input signal rise and fall time (tr, tf) are specified at 15 ns or less.
2. All timing is specified using 30% and 70% of VDD1 as the standard.

9.0 MECHANICAL DIAGRAM

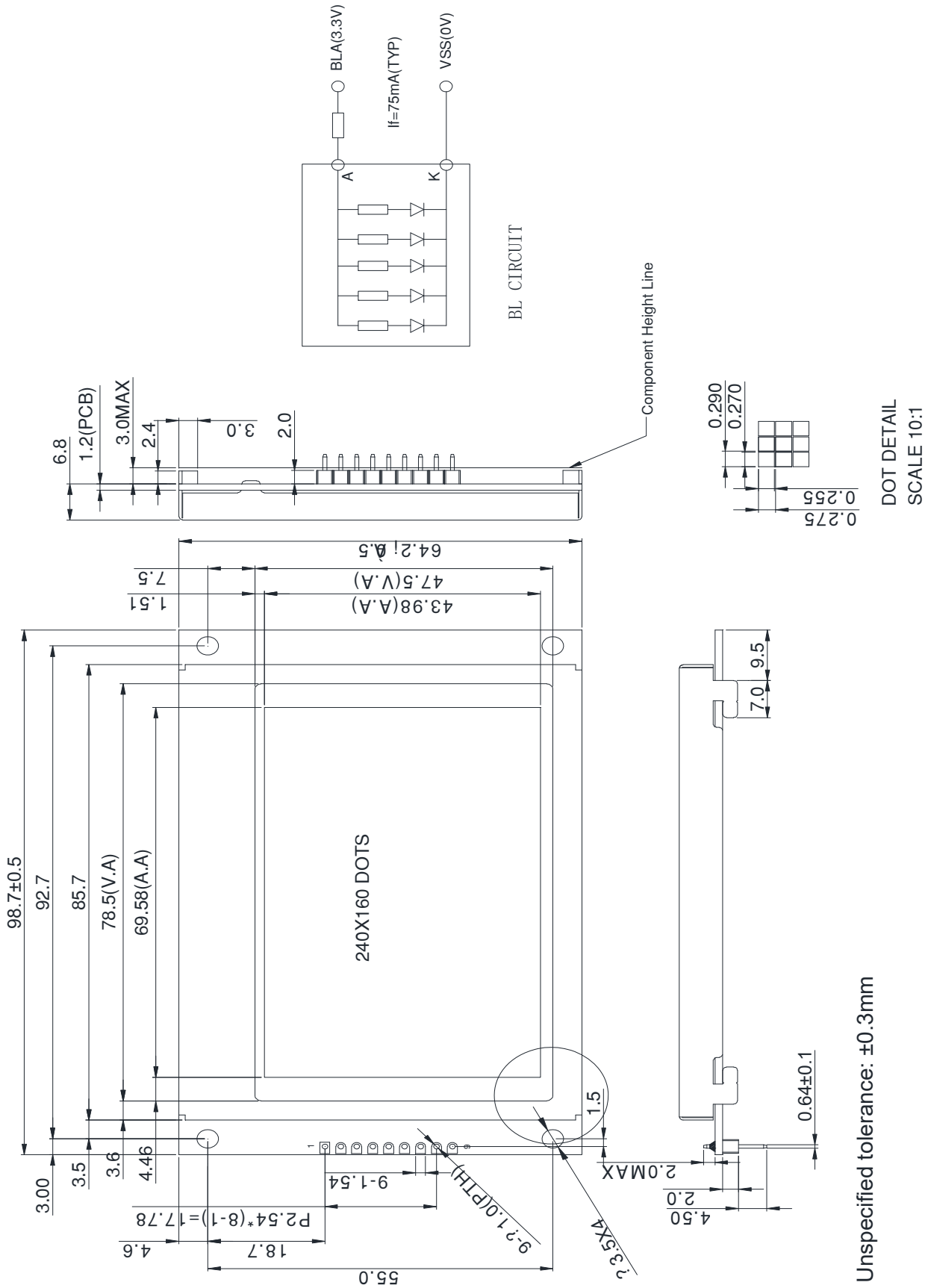

10.0 RELIABILITY TEST

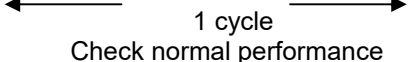
NO	Test Item	Description	Test Condition	Remark	
1	Environmental Test	High temperature storage	Applying the high storage temperature Under normal humidity for a long time Check normal performance	85°C 1000hrs	
2		Low temperature storage	Applying the low storage temperature Under normal humidity for a long time Check normal performance	-30°C 240hrs	
3		High temperature Operation	Apply the electric stress(Voltage and current) Under high temperature for a long time	80°C 1000hrs	Note1
4		Low temperature Operation	Apply the electric stress Under low temperature for a long time	-30°C 240hrs	Note1 Note2
5		High temperature/High Humidity Storage	Apply high temperature and high humidity storage for a long time	85% RH 85°C 1000hrs	Note2
6		Temperature Cycle	Apply the low and high temperature cycle -30°C <> 25°C <> 85°C <> 25°C 30min 10min 30min 10min  Check normal performance	-30°C/85°C 10 cycle	
7	Mechanical Test	Vibration test(Package state)	Applying vibration to product check normal performance	Freq:10~55~10Hz Amplitude:0.75mm 1cycle time:1min X.Y.Z every direction for 15 cycles	
8		Shock test(package state)	Applying shock to product check normal performance	Drop them through 70cm height to strike horizontal plane	
9	ESD Test	Direct contact Discharge	NA	+/-3KV	
		Air Discharge	NA	+/-8KV	

Remark

Note1:Normal operations condition (25°C±5°C).

Note2:Pay attention to keep dewdrops from the module during this test.

11.0 DISPLAY CONTROL INSTRUCTION

INSTRUCTION	A0	R/W	COMMAND BYTE								DESCRIPTION
			D7	D6	D5	D4	D3	D2	D1	D0	
NOP	0	0	0	0	0	0	0	0	0	0	No operation
RESET	0	0	0	0	0	0	0	0	0	1	Software reset
Power Save	0	0	0	0	0	1	0	0	0	SLP	Set power save mode SLP=0: Sleep in mode SLP=1: Sleep out mode
Partial Mode	0	0	0	0	0	1	0	0	1	PTL	Set partial mode PTL=0: Partial mode on PTL=1: Partial mode off
Inverse Display	0	0	0	0	1	0	0	0	0	INV	Set inverse display mode INV=0: Normal display INV=1: Inverse display
All Pixel ON/OFF	0	0	0	0	1	0	0	0	1	AP	Set all pixel on mode AP=0: All pixel off mode AP=1: All pixel on mode
Display ON/OFF	0	0	0	0	1	0	1	0	0	DSP	Set LCD display DSP=0: Display off DSP=1: Display on
Set Column Address	0	0	0	0	1	0	1	0	1	0	Set column address Starting column address: 00h ≤ XS ≤ 7Fh Ending column address: XS ≤ XE ≤ 7Fh
	1	0	XS15	XS14	XS13	XS12	XS11	XS10	XS9	XS8	
	1	0	XS7	XS6	XS5	XS4	XS3	XS2	XS1	XS0	
	1	0	XE15	XE14	XE13	XE12	XE11	XE10	XE9	XE8	
Set Row Address	0	0	0	0	1	0	1	0	1	1	Set row address Starting row address: 00h ≤ YS ≤ 9Fh Ending row address: YS ≤ YE ≤ 9FH
	1	0	YS15	YS14	YS13	YS12	YS11	YS10	YS9	YS8	
	1	0	YS7	YS6	YS5	YS4	YS3	YS2	YS1	YS0	
	1	0	YE15	YE14	YE13	YE12	YE11	YE10	YE9	YE8	
Write Display Data	0	0	0	0	1	0	1	1	0	0	Write display data to DDRAM
	1	0	D7	D6	D5	D4	D3	D2	D1	D0	
Read Display Data	0	0	0	0	1	0	1	1	1	0	Read display data from DDRAM
	1	1	D7	D6	D5	D4	D3	D2	D1	D0	
Partial Display Area	0	0	0	0	1	1	0	0	0	0	Set partial area Partial display address start: 00h ≤ PTS ≤ 9Fh Partial display address end: 00h ≤ PTE ≤ 9Fh Display Area: 64 ≤ Duty ≤ 160
	1	0	PTS15	PTS14	PTS13	PTS12	PTS11	PTS10	PTS9	PTS8	
	1	0	PTS7	PTS6	PTS5	PTS4	PTS3	PTS2	PTS1	PTS0	
	1	0	PTE15	PTE14	PTE13	PTE12	PTE11	PTE10	PTE9	PTE8	
Scroll Area	0	0	0	0	1	1	0	0	1	1	Set scroll area Top Area: TA=00h~A0h Scrolling Area: SA=00h~A0h Bottom Area: BA=00h~A0h TA+SA+BA=160
	1	0	TA7	TA6	TA5	TA4	TA3	TA2	TA1	TA0	
	1	0	SA7	SA6	SA5	SA4	SA3	SA2	SA1	SA0	
	1	0	BA7	BA6	BA5	BA4	BA3	BA2	BA1	BA0	
Display Control	0	0	0	0	1	1	0	1	1	0	Set scan direction of COM and SEG MY=0: COM0→COM159 MY=1: COM159→COOM0 MX[1:0]=(0,0): SEG0→SEG383 MX[1:0]=(1,1): SEG383→SEG0
	1	0	MY	MX1	0	0	MX0	0	0	0	
Start Line	0	0	0	0	1	1	0	1	1	1	Set display start line S=00h~9Fh
	1	0	S7	S6	S5	S4	S3	S2	S1	S0	

AQM2416D-FLW-FBE-T(ZETTLER DISPLAYS) GRAPHIC MODULE VER1.0



INSTRUCTION	A0	R/W	COMMAND BYTE								DESCRIPTION
			D7	D6	D5	D4	D3	D2	D1	D0	
Display Mode	0	0	0	0	1	1	1	0	0	M	Set display mode M=0: Gray mode M=1: Monochrome mode
Enable DDRAM Interface	0	0	0	0	1	1	1	0	1	0	Enable DDRAM interface RIF=0: Monochrome mode & 4-level gray scale mode RIF=1: 16-level gray scale mode
	1	0	0	0	0	0	0	0	1	RIF	
Display Duty	0	0	1	0	1	1	0	0	0	0	Set display duty DT=03h~9Fh
	1	0	DT7	DT8	DT5	DT4	DT3	DT2	DT1	DT0	
First Output COM	0	0	1	0	1	1	0	0	0	1	Set first output COM FC=00h~9Fh
	1	0	FC7	FC6	FC5	FC4	FC3	FC2	FC1	FC0	
FOSC Divider	0	0	1	0	1	1	0	0	1	1	Set FOSC dividing ratio
	1	0	0	0	0	0	0	0	FOD1	FOD0	
Partial Display	0	0	1	0	1	1	0	1	0	0	Set partial display mode
	1	0	1	0	1	0	0	0	0	0	
N-Line Inversion	0	0	1	0	1	1	0	1	0	1	Set N-Line inversion
	1	0	M	0	0	NL4	NL3	NL2	NL1	NL0	
Read Modify Write	0	0	1	0	1	1	1	0	0	RMW	Read modify write control RMW=0: Enable read modify write RMW=1: Disable read modify write
Set Vop	0	0	1	1	0	0	0	0	0	0	Set Vop
	1	0	Vop7	Vop6	Vop5	Vop4	Vop3	Vop2	Vop1	Vop0	
	1	0	-	-	-	-	-	-	-	Vop8	
Vop Increase	0	0	1	1	0	0	0	0	0	1	Vop increase one step
Vop Decrease	0	0	1	1	0	0	0	0	1	0	Vop decrease one step
BIAS System	0	0	1	1	0	0	0	0	1	1	Set BIAS system
	1	0	-	-	-	-	-	BS2	BS1	BS0	
Booster Level	0	0	1	1	0	0	0	1	0	0	Set booster level
	1	0	-	-	-	-	-	BST2	BST1	BST0	
Vop Offset	0	0	1	1	0	0	0	1	1	1	Set Vop offset
	1	0	0	VOF6	VOF5	VOF4	VOF3	VOF2	VOF1	VOF0	
Analog Control	0	0	1	1	0	1	0	0	0	0	Enable analog circuit
	1	0	0	0	0	1	1	1	0	1	
Auto Read Control	0	0	1	1	0	1	0	1	1	1	Auto read control XARD=0: Enable auto read XARD=1: Disable auto read
	1	0	1	0	0	XARD	1	1	1	1	
OTP WR/RD Control	0	0	1	1	1	0	0	0	0	0	OTP WR/RD control WR/RD=0: Enable OTP read WR/RD=1: Enable OTP write
	1	0	0	0	WR/RD	0	0	0	0	0	
OTP Control Out	0	0	1	1	1	0	0	0	0	1	OTP control out
OTP Write	0	0	1	1	1	0	0	0	1	0	OTP programming procedure
OTP Read	0	0	1	1	1	0	0	0	1	1	OTP up-load procedure
OTP Selection Control	0	0	1	1	1	0	0	1	0	0	OTP selection control Ctrl=0: Disable OTP Ctrl=1: Enable OTP
	1	0	0	Ctrl	0	1	1	0	0	1	
OTP Programming Setting	0	0	1	1	1	0	0	1	0	1	OTP programming setting
	1	0	0	0	0	0	1	1	1	1	

AQM2416D-FLW-FBE-T(ZETTLER DISPLAYS) GRAPHIC MODULE VER1.0

INSTRUCTION	A0	R/W	COMMAND BYTE								DESCRIPTION
			D7	D6	D5	D4	D3	D2	D1	D0	
Frame Rate (Gray Scale Mode)	0	0	1	1	1	1	0	0	0	0	Frame rate setting in different temperature range (Gray scale mode)
	1	0	-	-	-	FRA4	FRA3	FRA2	FRA1	FRA0	
	1	0	-	-	-	FRB4	FRB3	FRB2	FRB1	FRB0	
	1	0	-	-	-	FRC4	FRC3	FRC2	FRC1	FRC0	
Frame Rate (Monochrome Mode)	0	0	1	1	1	1	0	0	0	1	Frame rate setting in different temperature range (Monochrome mode)
	1	0	-	-	-	FRA4	FRA3	FRA2	FRA1	FRA0	
	1	0	-	-	-	FRB4	FRB3	FRB2	FRB1	FRB0	
	1	0	-	-	-	FRC4	FRC3	FRC2	FRC1	FRC0	
Temperature Range	0	0	1	1	1	1	0	0	1	0	Temperature range setting
	1	0	-	TA6	TA5	TA4	TA3	TA2	TA1	TA0	
	1	0	-	TB6	TB5	TB4	TB3	TB2	TB1	TB0	
	1	0	-	TC6	TC5	TC4	TC3	TC2	TC1	TC0	
Temperature Gradient Compensation	0	0	1	1	1	1	0	1	0	0	Set temperature gradient compensation coefficient
	1	0	MT13	MT12	MT11	MT10	MT03	MT02	MT01	MT00	
	1	0	MT33	MT32	MT31	MT30	MT23	MT22	MT21	MT20	
	1	0	MT53	MT52	MT51	MT50	MT43	MT42	MT41	MT40	
	1	0	MT73	MT72	MT71	MT70	MT63	MT62	MT61	MT60	
	1	0	MT93	MT92	MT91	MT90	MT83	MT82	MT81	MT80	
	1	0	MTB3	MTB2	MTB1	MTB0	MTA3	MTA2	MTA1	MTA0	
	1	0	MTD3	MTD2	MTD1	MTD0	MTC3	MTC2	MTC1	MTC0	
1	0	MTF3	MTF2	MTF1	MTF0	MTE3	MTE2	MTE1	MTE0		

For more details, please refer to IC ST7586 Dstasheet

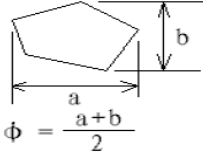
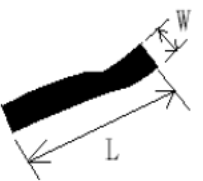
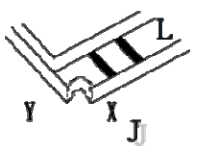
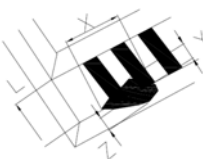
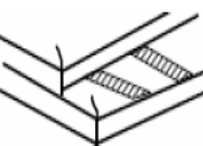
12.0 APPEARANCE CRITERIA

Item	Description	Picture	Specification			MA	MI	Inspection Method
Dot defects (black/white dot)	Scratches black dot white dot on the polarizer dirty spot and bubble between the polarizer and glass in the display area.	 <p>$\phi = \frac{a+b}{2}$</p> <p>J:the distance between dot and dot.</p>	≤ 0.1	Ignored		●		Visual/contrast by Inspection standard film
			$0.1 < \phi \leq 0.20$	2	$J > 5$			
			$0.20 < \phi \leq 0.25$	1	$J > 10$			
			$0.25 < \phi \leq 0.30$	0				
			$0\phi > 0.3$	0				
black/white line defect (straight line or curve etc. Line type defects)	Fibres in active area, scratches and black line on the glass or polarizer.	 <p>J:the distance between dot and dot.</p>	$W \leq 0.01$	Ignored		●		Visual/contrast by Inspection standard film
			$W \leq 0.02 \quad L \leq 5$	2	$J > 5$			
			$W \leq 0.03 \quad L \leq 4$	1	$J > 10$			
			$W \leq 0.04 \quad L \leq 3$	0	$J > 10$			
			$W \leq 0.05 \quad L \leq 2$	0				
Chip on corner	sidestep on the lower glass	 <p>Y:width of chip X:length of chip L:width of sidestep J:distance between electrode and the farthermost edge.</p>	$Y \leq 1/2L, X \leq 1$	Ignored		●		Visual/contrast by Inspection standard film
			$Y \leq 1/2L, X \leq 2$	2				
			$Y \leq 1/2L, X \leq 3$	1				
			$Y \leq 1/2L, X \leq 1/3J$	0	$J \leq 3$			
			$Y \leq 1/2L, X \leq 2/3J$	0	$J \leq 3$			
Crack		 <p>Y:width of crack X:length of crack L:width of sidestep T:depth of crack Z:thickness of single glass</p>	$Y \leq 1/5L \quad X \leq 5 \quad Z \leq 1/2T$	Ignored		●		Visual/contrast by Inspection standard film
			$Y \leq 1/4L \quad X \leq 5 \quad Z \leq 1/2T$	2				
			$Y \leq 1/3L \quad X \leq 5 \quad Z \leq 1/2T$	1				
			$Y \leq 1/3L \quad X \leq 10 \quad Z \leq 1/2T$	0				
			$Y \leq 1/3L \quad X \leq 15 \quad Z \leq 1/2T$	0				
Crack			Cracks in any area	rejected		●		Visual
Polarizer			≤ 0.8	Accepted		●		Visual/

AQM2416D-FLW-FBE-T(ZETTLER DISPLAYS) GRAPHIC MODULE VER1.0

		be applicable for up/bottom polarizer	0.8<L≤1.0	Rejected			contrast by Inspection standard film
			1.0<L≤1.5	Rejected			
			1.5<L≤2.0	Rejected			
			Any seeable polarizer slanting or excursion in active area will be rejected. The polarizer edge should be even and be line. Any indentation within 1/3 of silkscreen line will be rejected. Wrong direction, missing or extra, incorrect sticking for polarizer and dirty surface(grease) on polarizer will be rejected. seeable black silkscreen line from the arond can be accepted. Refer to the drawing size requirement.				
End seal		 <p>L: The distance from the block to edge of glass.</p>	UV glue of seal on the glass surface	Rejected	●	Visual/contrast by Inspection standard film	
			The UV glue of seal overflow into the active area.	Rejected			
			Direction of end seal is different from the drawing.	Rejected			
			Glue capacity of end seal < (1/3)*L	Rejected			
			the height and length of end seal is out of the drawing requirements.	Rejected			
Silkscreen line			silkscreen line overflow into the active area.	Rejected	●	Visual/contrast by Inspection standard film	
			silkscreen line deviated in active area.	Rejected			
			bubble of silkscreen line ≥ 1/3 width of silkscreen line	Rejected			

AQM2416D-FLW-FBE-T(ZETTLER DISPLAYS) GRAPHIC MODULE VER1.0

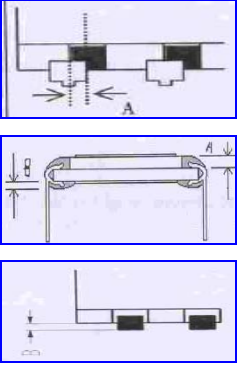
PIN			<p>Glue on PIN: there is glue on the PIN without pin clip will be rejected. PIN glue solidification: PIN glue doesn't solidify completely. The sunken or glue stain by touching will be rejected.</p> <p>PIN deflection: if deflection angle $> \pm 5^\circ$, rejected; contrarily, please refer to the drawing requirement. Without continuous glue on pins will be rejected. PIN glue stains on polarizer or inleakage polarizer and glass, rejected.</p> <p>PIN glue exceeds the up polarizer, rejected.</p> <p>Missing or extra, broken pin, rejected.</p> <p>PIN loosen: no permission for pin loose or drop. Clip</p> <p>PIN:pin center exceeds 1/3 ITO width, rejected. No pin glue, rejected. UV glue range: UV glue must be exceeded over 1~1.5 pin distance from both side. if not, rejected. PIN length and direction must be same with the drawing requirements.</p>		●	Visual/ contrast by Inspection standard film	
Protective film			<p>LCD protective film can not stick on the polarizer and the product protective film raised $\leq 1/3$ length or width of polarizer from same direction of axis and its total length should be $\leq 15\text{mm}$. This defect can be accepted.</p>		●	Visual	
Rainbow			rainbow is not in active area.	Accepted		●	Visual/co ntrast by golden sample
			Rainbow in active area.	Rejected			
			with obvious discoloration and uneven color.	Rejected			
background color			There are obvious different background color from the same product lot.	Rejected		●	Visual/co ntrast by golden sample

NOTE:

Inspection condition:

Viewing distance for cosmetic inspection is 30cm with bare eyes, and under an environment of 800 lux(20W*2---40W) light intensity, all directions for inspecting the sample should be within 45° against perpendicular line.

13.0 PRECAUTION FOR USING LCM

1. When design the product with this LCD Module, make sure the viewing angle matches to its purpose of usage.
2. As LCD panel is made of glass substrate, Dropping the LCD module or banging it against hard objects may cause cracking or fragmentation. Especially at corners and edges.
3. Although the polarizer of this LCD Module has the anti-glare coating, always be careful not to scratch its surface. Use of a plastic cover is recommended to protect the surface of polarizer.
4. If the LCD module is stored at below specified temperature, the LC material may freeze and be deteriorated. If it is stored at above specified temperature, the molecular orientation of the LC material may change to Liquid state and it may not revert to its original state. Excessive temperature and humidity could cause polarizer peel off or bubble. Therefore, the LCD module should always be stored within specified temperature range.
5. Saliva or water droplets must be wiped off immediately as those may leave stains or cause color changes if remained for a long time. Water vapor will cause corrosion of ITO electrodes.
6. If the surface of LCD panel needs to be cleaned, wipe it swiftly with cotton or other soft cloth. If it is not still clean enough, blow a breath on the surface and wipe again.
7. The module should be driven according to the specified ratings to avoid malfunction and permanent damage. Applying DC voltage cause a rapid deterioration of LC material. Make sure to apply alternating waveform by continuous application of the M signal. Especially the power ON/OFF sequence should be kept to avoid latch-up of driver LSIs and DC charge up to LCD panel.
8. Mechanical Considerations
 - a) LCM are assembled and adjusted with a high degree of precision. Avoid excessive shocks and do not make any alterations or modifications. The following should be noted.
 - b) Do not tamper in any way with the tabs on the metal frame.
 - c) Do not modify the PCB by drilling extra holes, changing its outline, moving its components or modifying its pattern.
 - d) Do not touch the elastomer connector; especially insert a backlight panel (for example, EL).
 - e) When mounting a LCM makes sure that the PCB is not under any stress such as bending or twisting. Elastomer contacts are very delicate and missing pixels could result from slight dislocation of any of the elements.
 - f) Avoid pressing on the metal bezel, otherwise the elastomer connector could be deformed and lose contact, resulting in missing pixels.
9. Static Electricity
 - a) Operator

Wear the electrostatics shielded clothes because human body may be statically charged if not wear shielded clothes. Never touch any of the conductive parts such as the LSI pads; the copper leads on the PCB and the interface terminals with any parts of the human body.

b) Equipment

There is a possibility that the static electricity is charged to the equipment, which has a function of peeling or friction action (ex: conveyer, soldering iron, working table). Earth the equipment through proper resistance (electrostatic earth: 1×10^8 ohm).

Only properly grounded soldering irons should be used.

If an electric screwdriver is used, it should be well grounded and shielded from commutator sparks.

The normal static prevention measures should be observed for work clothes and working benches; for the latter conductive (rubber) mat is recommended.

c) Floor

Floor is the important part to drain static electricity, which is generated by operators or equipment.

There is a possibility that charged static electricity is not properly drained in case of insulating floor. Set the electrostatic earth (electrostatic earth: 1×10^8 ohm).

d) Humidity

Proper humidity helps in reducing the chance of generating electrostatic charges. Humidity should be kept over 50%RH.

e) Transportation/storage

The storage materials also need to be anti-static treated because there is a possibility that the human body or storage materials such as containers may be statically charged by friction or peeling.

The modules should be kept in antistatic bags or other containers resistant to static for storage.

f) Soldering

Solder only to the I/O terminals. Use only soldering irons with proper grounding and no leakage.

Soldering temperature : $355^{\circ} \text{C} \pm 10^{\circ} \text{C}$

Soldering time: 3 to 4 sec.

Use eutectic solder with resin flux fill.

If flux is used, the LCD surface should be covered to avoid flux spatters. Flux residue should be removed afterwards.

g) Others

The laminator (protective film) is attached on the surface of LCD panel to prevent it from scratches or stains. It should be peeled off slowly using static eliminator.

Static eliminator should also be installed to the workbench to prevent LCD module from static charge.

10. Operation

- a) Driving voltage should be kept within specified range; excess voltage shortens display life.
 - b) Response time increases with decrease in temperature.
 - c) Display may turn black or dark blue at temperatures above its operational range; this is (however not pressing on the viewing area) may cause the segments to appear "fractured".
 - d) Mechanical disturbance during operation (such as pressing on the viewing area) may cause the segments to appear "fractured".
11. If any fluid leaks out of a damaged glass cell, wash off any human part that comes into contact with soap and water. The toxicity is extremely low but caution should be exercised at all the time.
 12. Disassembling the LCD module can cause permanent damage and it should be strictly avoided.
 13. LCD retains the display pattern when it is applied for long time (Image retention). To prevent image retention, do not apply the fixed pattern for a long time. Image retention is not a deterioration of LCD. It will be removed after display pattern is changed.
 14. Do not use any materials, which emit gas from epoxy resin (hardener for amine) and silicone adhesive agent (dealcohol or deoxym) to prevent discoloration of polarizer due to gas.
 15. Avoid the exposure of the module to the direct sunlight or strong ultraviolet light for a long time.